



FFalcon Soundbar FS1

FS1010-AU



User Manual

1 Important safety instructions

Important information



CAUTION

**RISK OF ELECTRIC SHOCK
DO NOT OPEN**



CAUTION: TO REDUCE THE RISK OF ELECTRIC SHOCK, DO NOT REMOVE COVER (OR BACK). NO USER-SERVICEABLE PARTS INSIDE. REFER SERVICING TO QUALIFIED SERVICE PERSONNEL.



The lightning flash with arrowhead symbol, within an equilateral triangle is intended to alert the user to the presence of uninsulated dangerous voltage within the product's enclosure that may be of sufficient magnitude to constitute a risk of electric shock.



The exclamation point within an equilateral triangle is intended to alert the user to the presence of important operating and maintenance (servicing) instructions in the literature accompanying the product.



This symbol indicates that this product incorporates double insulation between hazardous main voltage and user accessible parts. When servicing, use only identical replacement parts.

Warnings

- *To reduce the risk of fire or electric shock, do not expose this product to rain or moisture. This product should not be exposed to dripping or splashing. No objects filled with liquids, such as vases, should be placed on or near the product.*
- *The product is unstable if it is not properly placed or mounted to the wall. Be sure to follow the wall mounting instructions provided in this user manual or Quick start guide to ensure your safety.*
- *Do not expose batteries to excessive heat such as sunshine, fire, and so forth.*

Important safety instructions

- **Read these instructions** - Read all the safety and operating instructions before operating the product.
- **Retain these instructions** - Retain the safety and operating instructions for future reference.
- **Heed all warnings** - Adhere to all warnings on the product and in the operating instructions.
- **Follow all instructions** - Follow all operating and use instructions.
- **Do not use this apparatus near water** – The appliance should not be used near water or moisture – for example, in a wet basement or near a swimming pool and the like
- **Clean only with a dry cloth.**
- **Do not block any ventilation openings.** Install in accordance with the manufacturer's instructions.
- **Do not install near any heat sources** such as radiators, heat registers, stoves, or other apparatus (including amplifiers) that produce heat.
- **Protect the power cord** from being walked on or pinched particularly at plugs, convenience receptacles, and the point where it exits from the product.

- **Use only attachments/accessories** specified by the manufacturer.



- **Use only with the cart**, stand, tripod, bracket, or table specified by the manufacturer, or sold with the apparatus. When a cart is used, use caution when moving the cart/apparatus combination to avoid injury from tip-over.



- **Unplug this apparatus** during lightning storms or when unused for long periods of time.
- **Refer all servicing** to qualified service personnel. Servicing is required when the apparatus has been damaged in any way, such as power-supply cord or plug damaged, liquid has been spilled or objects have fallen into the apparatus, the apparatus has been exposed to rain or moisture, does not operate normally, or has been dropped.

Cautions

- The product shall not be exposed to dripping or splashing.
- Do not place any sources of danger on the product (for example, liquid filled objects, lighted candles).
- Disconnect the power adapter to shut off when you find trouble or when not in use. The power adapter shall be easy to access.

- Use of controls or adjustments or performance of procedures other than those described herein, may result in hazardous radiation exposure or other unsafe operation.
- The power adapter/appliance coupler is used as the disconnect device, the disconnect device must remain readily accessible.
- Danger of explosion if battery is incorrectly replaced. Replace only with the same or equivalent type.
- No naked flame sources, such as lighted candles, should be placed on the apparatus.

Battery Caution and Disposal Information

- Install only new batteries of the same type in your product.
- Failure to insert batteries in the correct polarity, as indicated in the battery compartment, may shorten the life of the batteries or cause batteries to leak.
- Do not mix old and new batteries.
- Do not use rechargeable (Nickel Cadmium) or (Nickel Metal Hydride) batteries.
- Do not mix alkaline, standard (Carbon-Zinc) or rechargeable (Nickel Cadmium) or (Nickel Metal Hydride) batteries.
- Do not dispose of batteries in fire, water or a hot oven, or mechanically crushing or cutting of a battery.
- Leaving a battery in an extremely high temperature surrounding environment that can result in an explosion or the leakage of flammable liquid or gas.
- A battery subjected to extremely low air pressure that may result in an explosion or the leakage of flammable liquid or gas.

- Recycle or dispose of batteries as per state and local guidelines.
- Danger of explosion if battery is incorrectly replaced. Replace only with the same or equivalent type.
- When the remote control is not to be used for a long time (more than a month), remove the battery from the remote control to prevent it from leaking.
- If the batteries leak, wipe away the leakage inside the battery compartment and replace the batteries with new ones.
- Keep away the batteries from heat or moisture.
- Do not carry or store batteries with other metallic objects.
- Doing so could cause batteries to short circuit, leak or explode.
- Never recharge a battery unless it is confirmed to be a rechargeable type.
- The product/remote control contains a coin/button type battery, which can be swallowed. Keep the battery out of reach of children at all times! If swallowed, the battery can cause serious injury or death. Severe internal burns can occur within two hours of ingestion.
- If you suspect that a battery has been swallowed or placed inside any part of the body, seek immediate medical attention.
- When you change the batteries, always keep all new and used batteries out of reach of children. Ensure that the battery compartment is completely secure after you replace the battery.
- If the battery compartment cannot be completely secured, discontinue use of the product. Keep out of reach of children and contact the manufacturer.

Installation location

- This product is designed to sit on a firm, flat surface. Do not place the product on built-in installation such as a bookcase or rack because the ventilation slots around the product will be blocked, resulting in reduced lifetime from overheating. To assure adequate ventilation for this product, maintain a spacing of 20cm or more around the product.
- Make sure the product on the furniture is of adequate size and strength to prevent it from being accidentally tipped over, pushed off, or pulled off. This could cause personal injury and/or damage to the product.
- Installation of wall mount must be carried out by qualified personnel only. Incorrect assembly can result in severe personal injury and property damage (if you intend to install this product yourself, you must check for installations such as electrical wiring and plumbing that may be buried inside the wall). It is the installer's responsibility to verify that the wall will safely support the total load of the product and wall mount brackets.

Mount your Sound Bar main unit on the wall

You can choose to place your Sound Bar main unit below the center of your TV or mount it on the wall.



1. Place the supplied wall mount template on the wall. Make sure the wall mount template is at least 10cm below the center of the TV.
2. Use a level to make sure the Sound Bar is positioned accurately.
3. Use the tape to stick the wall mount template firmly on the wall.
4. Mark on the wall using each marking on the template through the mounting holes.
5. Take away the wall mount template.
6. Drill a screw hole at each marking on the wall.

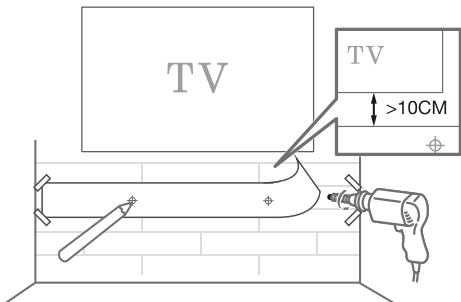

7. Take out the screws from the rear of the soundbar, 2 per side
8. Using a screwdriver, attach the mounting brackets to the soundbar.
9. Installation Complete

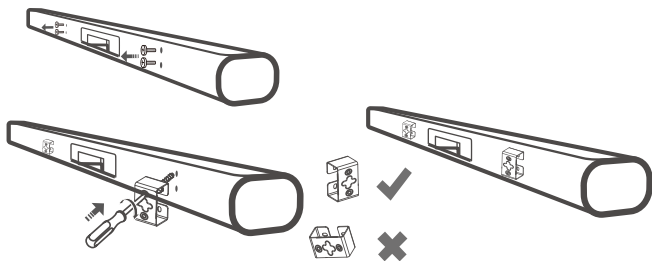

10. Insert the supplied wall anchors into 2 screw holes on the wall.
11. Insert the supplied screws into the wall anchors.
12. Fix and tighten the screws on the wall.
13. Hang the Sound Bar main unit on the screws.

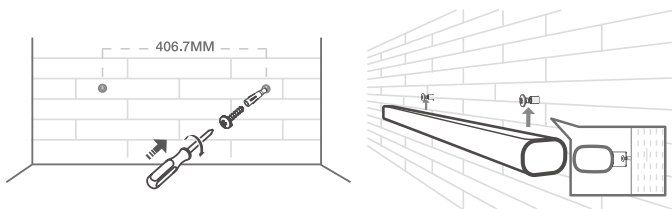

Product panel introduction

Button and jack definition:

There are 4 buttons; there are 8 jacks, which are defined as follows:

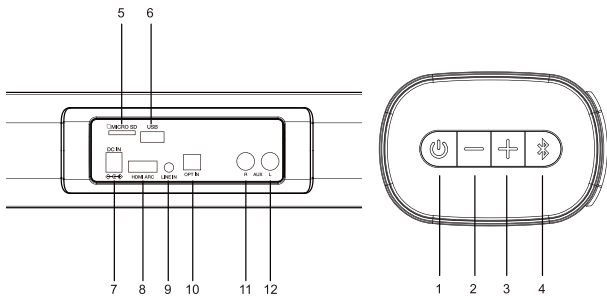

1. : Press to power on, short press to switch function, long press to power off
2. : Press for volume down
3. : Press for volume up
4. : Press for Bluetooth pairing
5. MICRO SD
6. USB
7. DC IN: DC14V 2A input
8. HDMI: HDMI ARC
9. LINE IN: 3.5mm connector
10. OPT: Optical input
11. AUX IN(R&L): For external audio input (RCA)

Function indicator light:

1. Red light: in standby mode
2. White light: in operation

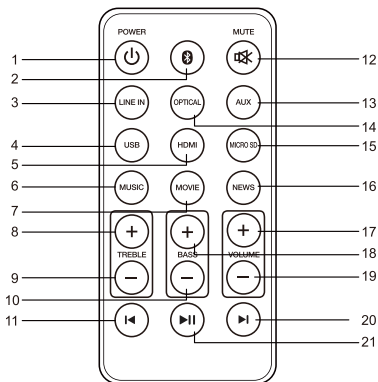

Function of each button

1. : Press to power on and power off
2. : Press to switch to Bluetooth mode, long press to bluetooth pairing
3. LINE IN: Press to switch to LINE IN input
4. USB: Press to switch to USB play when insert USB
5. HDMI: Press to switch to HDMI mode

6. MUSIC: Press to select the MUSIC sound mode
7. MOVIE: Press to select the MOVIE sound mode
8. TREBLE +: Press to increase treble sound (the white light flashes, when hit the maximum or minimum level white light will be on)
9. TREBLE -: Press to decrease treble sound (the white light flashes, when hit the maximum or minimum level white light will be on)
10. BASS -: Press to decrease bass sound (the white light flashes, when hit the maximum or minimum level white light will be on)
11. ◀: Press to previous song under Bluetooth, USB or MICRO SD mode
12. MUTE: Press the mute button and turn on the sound button (white light will flash slowly when mute)
13. AUX: Press to switch to external AUX input
14. OPTICAL: Press to switch to the Optical input mode
15. MICRO SD: Press to MICRO SD play
16. NEWS: Press to select the NEWS sound mode
17. VOL +: Press or long press to increase volume (the white light flashes, when hit the maximum or minimum level white light will be on)
18. BASS +: Press to increase bass (the white light flashes, when hit the maximum or minimum level white light will be on)
19. VOL -: Press or long press to decrease volume (the white light flashes, when hit the maximum or minimum level white light will be on)
20. ▶: Press to next song under Bluetooth, USB or MICRO SD mode
21. ▶||: Press to play or pause playing under Bluetooth, USB or MICRO SD

Get Started:

1. Make sure you have made all the necessary cable connections before connecting the Soundbar to a wall outlet, the soundbar will enter to standby mode, the indicator will light up in red.
2. Make sure the subwoofer is connected to the power, and turn the button to “ON”
3. Press “⏻” on unit or remote control to turn on the soundbar. The Bluetooth indicator will light up.
4. Approximately 20 seconds after you have selected the mode (Bluetooth/USB/MICRO SD/Line in/Optical/Aux/HDMI), the LED indicator will turn off. When you press a function button on the remote control, the LED will turn back on again.

Operation instruction

● Bluetooth Mode

1. Power on the Soundbar by pressing the “⏻” button.
2. Press the “📶” button on the unit or long press the “📶” button on the Remote control, a voice will say “Bluetooth pairing”. Keep distance between BT devices within 3 feet.
3. Select “FFalcon FS1” on the pairing list of Bluetooth device to pair. If your device requests a password, enter the default password 0000. Refer to the user’s manual for your specific device for instructions on pairing and connecting Bluetooth devices.
4. When successfully paired, a voice will announce, “Bluetooth device connected,” and the LED indicator will turn solid white. Now BT device can play audio through the soundbar.

5. After initial pairing, anytime the Soundbar powers ON it will automatically connect to the previous Bluetooth device used. Note: If your device become unpaired or you find it is unable to connect, press & hold the “” button (sound bar) to enter to Pairing Mode. A voice will announce, “Bluetooth device disconnected,” and you can connect to the soundbar manually.

● **LINE IN Mode**

After power on, connect the external audio sources to the LINE IN jack of soundbar by using the 3.5mm audio cable, and then Press the “” button on the soundbar or the “LINE IN” button on the remote control to switch to “LINE IN” mode. At this time, music from the external audio sources such as MP3/CD can be played. (please adjust the volume of the external audio sources accordingly at a comfortable level.)

● **AUX IN Mode**

After power on, connect external audio sources, such as CD/TV to the AUX in jack of the soundbar by using the RCA cable, and then Press the “” button on the soundbar or the “AUX” button on the remote control to switch to “AUX IN” mode. At this time, music from the external audio sources can be played. (please adjust the volume of the external sound source accordingly at a comfortable level.)

● **HDMI ARC Mode**



Press the “” button on the soundbar or “HDMI” button on the remote control to switch to “HDMI ARC” mode. At this point, connect the HDMI cable to the TV set and then to the HDMI ARC jack on the back of the soundbar. Ensure the HDMI ARC function is activated on your TV, and digital output is set to PCM.

● **OPTICAL Mode**



Press the “” button on the soundbar or “OPTICAL” button on the remote control to switch to “OPTICAL” mode. At this time, connect the DVD audio and equipment to Soundbar’s OPT IN jack with the optical cable. This machine decodes optical fiber digital to restore sound through power amplifier.

Note : If there has the dust cover, remove it from the optical jack before you connect the optical cable. Ensure your TVs digital output is set to PCM.

● **USB Mode**

After power on, insert the USB into the USB jack of the soundbar; the machine automatically goes to USB playback mode and plays the music in USB. Press the “” button to play and pause the music. Press “” or “” button to select music up and down.

● **MICRO SD Mode**

After power on, insert the MICRO SD card into the MICRO SD jack of the soundbar; the machine automatically goes to MICRO SD playback mode and plays the music in MICRO SD card. Press the “” button to play and pause the music. Press “” or “” button to select music up and down.

Volume and Sound effect regulation

- A. After power on, in any mode of playback, Press or long press the volume “-” button on the soundbar or remote control to lower the volume. Press or long press the volume “+” button on the soundbar or remote control to raise the volume.

Note : When the maximum or minimum volume is reached, the LED light will be on and a beep will be heard.

- B. After power on, in any mode of playback, Press the remote control to choose sound effect mode: MUSIC, MOVIE and NEWS.

Note: The user can adjust each kind of sound effect mode to enjoy the music according to the personal preference!

Power off:

When the machine is power on, long press “⏻” button on soundbar or Press “⏻” button on remote control to power off, If the machine is unplugged from power supply, the machine will be completely powered off.

When the machine is power on,press “” on the subwoofer back side to power off.

Specification

Product name	FS1010-AU
AC/DC adaptor	Input: 100-240V~50/60Hz 1.0A MAX Output: 14V \equiv 2A
	Manufacturer: DONGGUAN DONGSONG ELECTRONIC CO.,LTD
	Model Number : DYS836-140200W-4
Frequency response	50Hz-20KHz
Bluetooth version	5.0
Bluetooth range	Up to 10m
Included in the packaging	Soundbar, Subwoofer, Remote control, AC/DC adaptor, RCA to 3.5mm cable, User manual, QSG, Wall-mounted bracket and screws, wall mount template
Dimensions/ Weight	Soundbar: 810 x 70 x 99 mm/1.50 kg Subwoofer: 165 x 240 x 298 mm/2.05 kg
Remote Control	Distance/Angel: 6m/30° Battery type: Lithium CR2025 battery

FAQ

Question	Answer approach
Bluetooth paired connection cannot be completed	Another mobile device may be connected to the soundbar. Disconnect the other connected Bluetooth device. Once the device is disconnected, your device should pair automatically—provided it was previously paired.
Volume of Bluetooth playback is low	<ol style="list-style-type: none">1. After connections with mobile devices, the volume of Bluetooth device is not up—but at the default output level. Turn up the mobile device volume.2. Output volume of Bluetooth device is low itself.
Short Bluetooth connection distance	Obstruction exists between mobile devices and Bluetooth device. Remove obstructions.
Bluetooth connection plays normally, sometimes with broken sound.	<ol style="list-style-type: none">1. Obstruction exists between mobile devices and Bluetooth device. Remove obstructions.2. Too far away from Bluetooth device to connected mobile devices, beyond the connection range. Shorten the distance between the Bluetooth device and mobile devices.

Subwoofer not working	Turn on the soundbar then press and hold both the button of Volume+ and Volume- for 3-5 seconds, then turn on the subwoofer, the red LED on Subwoofer will flash for 4 times. Plug off the AC adaptor from the soundbar, restart the device and complete the pair between the soundbar and subwoofer.
Play no sound	Make sure you activate the PCM signal output on your TV or device when the HDMI ARC/Optical audio source is selected on the sound bar. For more information of how to activate the PCM signal output, check the user manual of your TV or device.

Note : If you try all of the above remedies without success, please contact FFalcon customer service!

WARNING:

BATTERIES EITHER INSTALLED OR PACKED MUST NOT BE TO HEAT LIKE DIRECT SUNLIGHT, FIRE OR SIMILAR

Trademarks

Bluetooth



The Bluetooth® word mark and logos are registered trademarks owned by Bluetooth SIG, Inc. and any use of such marks by TCL Electronics Australia Pty Ltd. under license. Other trademarks and trade names are those of their respective owners.

HDMI



HDMI, and HDMI logo and High-Definition Multimedia Interface are trademarks or registered trademarks of HDMI licensing LLC.

www.ffalcon.com.au

Customer Support: 1300 170 540



**TAKE CARE WHEN
REMOVING THE SOUNDBAR**

2019 © TCL Electronics Australia Pty Ltd. All rights reserved. This product has been manufactured by and is sold under the responsibility of TCL Electronics Australia Pty Ltd.

FS1010_AU_UM_V1.0



技术要求:

- 1.名称: 说明书
- 2.尺寸: 105*148MM(成品尺寸)
- 3.材质: 80G书写纸, 骑马钉
- 4.颜色: 单黑
- 5.数量: 1台/说明书